

1. CLXVI = _____
 a) 156 b) 166 c) 146 d) 206
2. How many hundreds are there in 5127800?
 a) 800 b) 8 c) 80 d) 0
3. One lakh is = _____
 a) Thousand c) Hundred thousand
 b) Two thousand d) Million
4. A visitors at the Gujarat Culture Center can hear beautiful music played on bells. The music is played on 1 high-note bell and 2 sets of 20 bells. Which of the following expressions should be used to find the total number of bells?
 a) $1 + 2 - 32$ b) $1 \times 2 + 20$ c) $1 - 2 \times 21$ d) $1 + 2 \times 20$
5. Given that 20 is the 2nd common multiple of 2 and _____. Find the smallest possible number for
 a) 3 b) 5 c) 7 d) 9
6. In a school, there are 704 desks to place into 22 classrooms. If the same number of desks is placed in each classroom, how many desks will be there in each room?
 a) 42 b) 44 c) 32 d) 34
7. What fraction of the large square is red? What fraction of the large square is blue? What fraction of the large square is orange? What fraction of the large square is green? What fraction of the large square is black? What fraction of the large square is yellow?
- 
- a) red: $\frac{1}{4}$, blue: $\frac{1}{16}$, green: $\frac{1}{32}$, orange: $\frac{3}{32}$, black: $\frac{3}{16}$, yellow: $\frac{3}{16}$
 b) red: $\frac{4}{4}$, blue: $\frac{1}{16}$, green: $\frac{1}{16}$, orange: $\frac{3}{32}$, black: $\frac{3}{16}$, yellow: $\frac{3}{16}$
 c) red: $\frac{1}{4}$, blue: $\frac{1}{16}$, green: $\frac{1}{16}$, orange: $\frac{3}{16}$, black: $\frac{3}{16}$, yellow: $\frac{3}{16}$
 d) None of the above
8. How many minutes in $\frac{3}{4}$ of an hour?
 a) 35 minutes b) 45 minutes c) 15 minutes d) 30 minutes
9. On field day, Ravina jumped $4\frac{3}{14}$ feet and Neha jumped $2\frac{1}{7}$ feet. How much farther did Ravina jump than Neha?
 a) $2\frac{1}{14}$ b) $-2\frac{3}{14}$ c) $2\frac{3}{14}$ d) $-2\frac{1}{14}$
10. Temperature is measured in which of the following unit?
 a) Celsius c) Fahrenheit
 b) Kelvin d) All of the above

Study carefully and answer the following questions. (11 and 12)

11. Which type of rice is a better bargain?

- a) Healthy
- b) Yummy
- c) Insufficient data
- d) None of the above

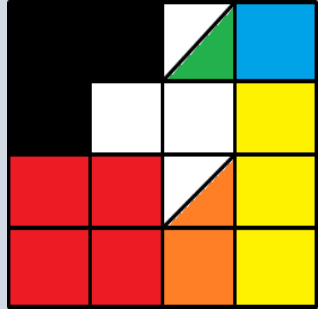

Rs 9.45 per 5 kg packet



Rs 14.80 per 8 kg packet

12. Which type of rice has a more price?

- a) Yummy
- b) Healthy
- c) Insufficient data
- d) None of the above

13. Find the area of TUVW.

- a) 230 cm^2
- b) 200 cm^2
- c) 220 cm^2
- d) 100 cm^2

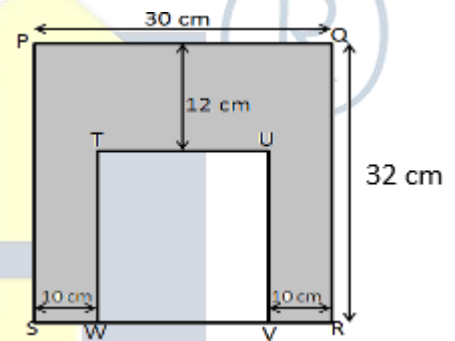

14. Which figure has minimum area?

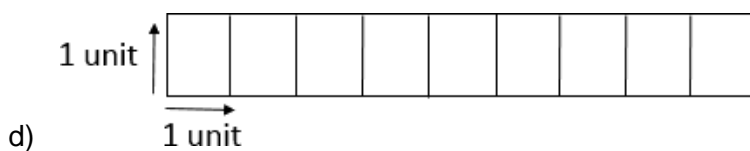
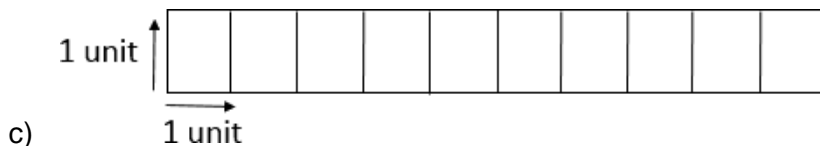
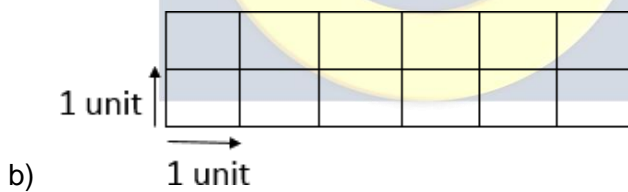

15. What angle best describe M?

- a) Acute angle
- b) Right angle
- c) Obtuse angle
- d) Straight angle



16. How many lines of symmetry does the figure have?

- a) 1
- b) 0
- c) 3
- d) 2

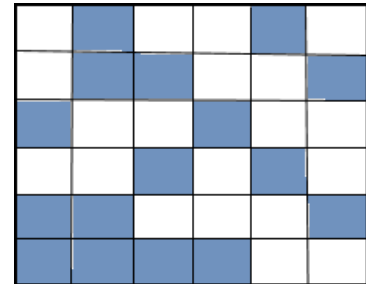

17. How many lines of symmetry does the following figure have?

- a) 4
- b) 3
- c) 5
- d) 2

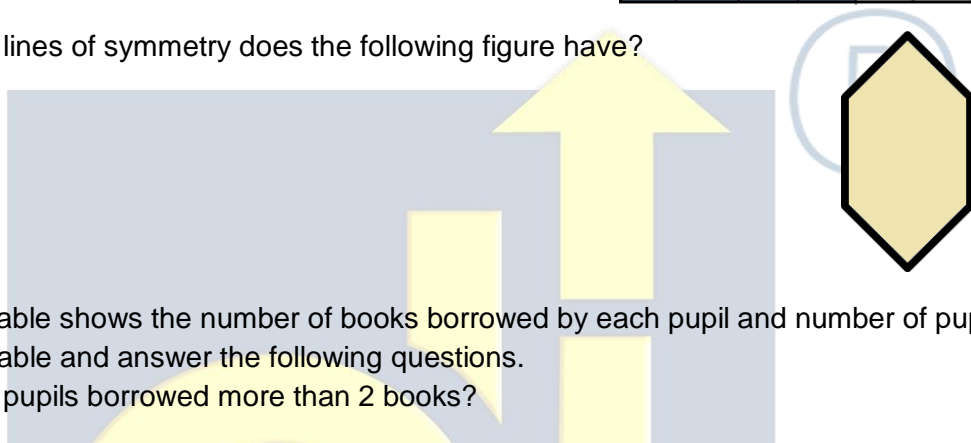

18. Following table shows the number of books borrowed by each pupil and number of pupils. Study the table and answer the following questions.

How many pupils borrowed more than 2 books?

- a) 133
- b) 123
- c) 418
- d) 320

Number of book borrowed by each pupil	0	1	2	3	4
Number of pupils	98	136	184	95	28

19. Choose the odd one out.

- a) CHMR
- b) BGLQ
- c) GLQV
- d) BLJT

20. Find the missing number.

- a) 113
- b) 126
- c) 135
- d) 93

2	33	5
3	63	6
4	?	7